

MADE IN GERMANY

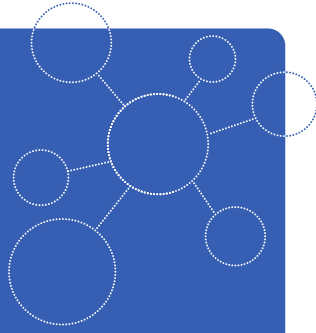

TRANSMITTER^{EVO}

Infrared gas detector
 Refrigerant (Opteon™ XP10) R513a
 2000 ppm
 smartGAS item number: T4-852205-03000



- Ready to install
- IP54 protection
- 12 - 28V DC supply voltage

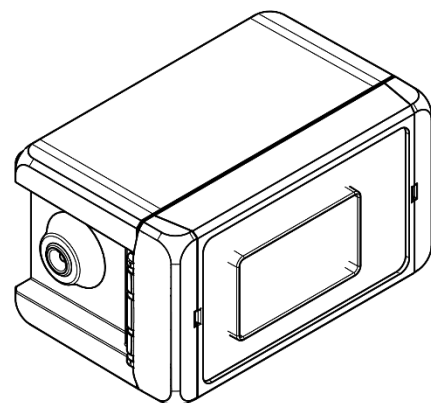
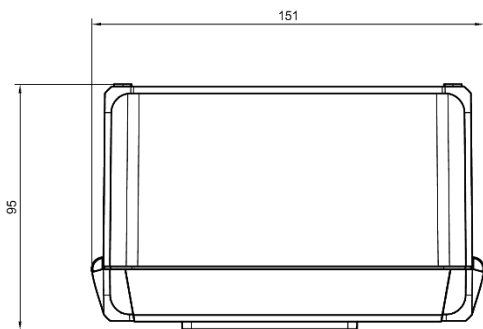
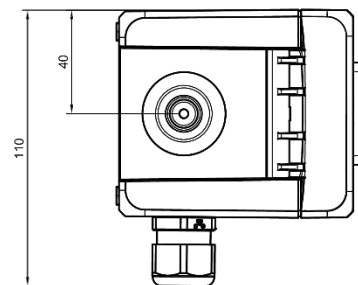
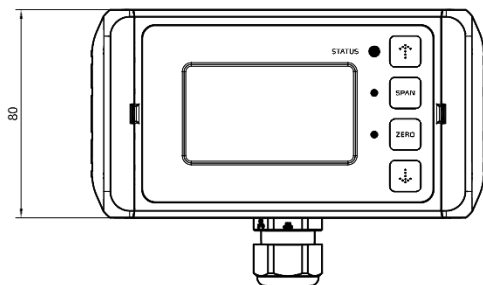

Application examples

Hotel air conditions
 Laboratories
 Hospitals
 Research
 Food transport

Available equipment

Calibration software
 Calibration adapter
 Calibration gas

Available design in support

Mechanical installation
 Data communication

General features

Measurement principle:	Non Dispersive Infra-Red (NDIR), dual wavelength
Measurement range:	0 ... 2000 ppm Full Scale (FS)
Gas supply:	by diffusion (atmospheric pressure)
Mounting dimensions:	151 mm x 80 mm x 95 mm (L x W x H)
Warm-up time:	< 2 minutes (start up time) < 11 minutes (fade in finished) < 30 minutes (full specification)
Protection class:	IP54
Electrical connection:	Cable diameter without adapter plug max. 1.5 mm ² (single wire) or 1 mm ² (strand). Cable diameter with adapter max. 2.5 mm ²

Measuring response*

Response time (t ₉₀):	appr. 60 s
Digital resolution:	1 ppm
Detection limit (3 σ):	≤ 5 ppm
Repeatability:	≤ ± 7 ppm
Linearity error (straight line deviation):	≤ ± 10 ppm
Long term stability (zero):	≤ ± 30 ppm over 12 month period
Long term stability (span):	≤ ± 40 ppm over 12 month period

Influence of T, P, other*

Temp. dependence (zero):	≤ ± 1 ppm per °C
Temp. dependence (span):	≤ ± 1 ppm per °C
Pressure dependence:	+ 0.100 % of actual reading / hPa

Electrical parameters

Supply voltage	12 V . . . 28 VDC
Supply current (peak):	< 85 mA @ 12 V, < 45 mA @ 28 V
Inrush current:	< 100 mA
Average power consumption:	< 1000 mW
Digital output signal:	Modbus ASCII / RTU via RS 485, autobaud, autoframe
Analogue output signal:	0(4) –20 mA, max 500 Ω / 0-2 V / 0-5 V / 0-10 V (DC)
Calibration:	zero and span by SW or push buttons

Climatic conditions

Operating temperature:	-20 ... + 40 °C
Storage temperature:	-20 ... + 60 °C
Air pressure:	800 ... 1150 hPa
Ambient humidity:	0 ... 95 % relative humidity (not condensing)

* Typical values related to 1013 hPa, T_a = 22 °C, flow = 0.7 l / min for dry (not condensing) and clean sample gas. Stated values exclude calibration gas tolerance.

All rights reserved. Any logos and/or product names are trademarks of smartGAS. The reproduction, transfer, distribution or storage of information contained in this brochure in any form without the prior written consent of smartGAS is strictly prohibited. All specifications – technical included – are subject to change without notice. Depending on the application, the target gas and the measurement range the technical data may differ. No liability is accepted for any consequential losses, injury or damage resulting from the use of this document or from any omissions or errors herein. The data is given for guidance only. It does not constitute a specification or an offer for sale.

For more information, please visit www.smartgas.eu or contact us at sales@smartgas.eu

Please consult smartGAS sales for parts specified with other temperature and measurement ranges. At first initiation and depending on application and ambient conditions recalibration is recommended. Recurring cycles of recalibration are recommended.